

Universal socket strip 8-fold

Item-No.: 0200x00082301 (1,5 m cord) | 0200x00082303 (3 m cord) | 0200x00082305 (5 m cord)



Robust plastic, grey

Built-in sockets (90° rotated), round

Extra large space in between sockets 64 mm

1,5 m power cord and angle plug (optional with 3 m or 5 m power cord)

Expanded contact protection by using a shutter



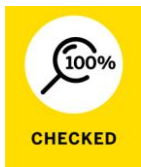

End caps with mounting possibility

VDE certified



Universal socket strip 8-fold

Technical data

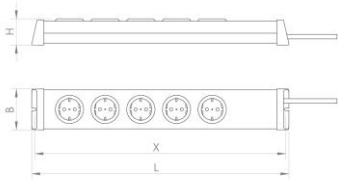
3.600 W Power	250 V ~ / 50 Hz Rated voltage	16 A Rated current									
Power Cord: H05VV-F 3G 1,5 mm ² Plug: CEE 7/7 plug Type EF, angled Sockets: earthing contact Type F Safety class: IP20		   									
 <p>(similar illustration)</p>											
<table border="0"> <tr> <td>Item-No. 0200x00082301 (1,5 m cord)</td> <td>EAN 401209602418 7</td> <td>PU 10</td> </tr> <tr> <td>Item-No. 0200x00082303 (3 m cord)</td> <td>EAN 401209602419 4</td> <td>PU 10</td> </tr> <tr> <td>Item-No. 0200x00082305 (5 m cord)</td> <td>EAN 401209602448 4</td> <td>PU 7</td> </tr> </table>		Item-No. 0200x00082301 (1,5 m cord)	EAN 401209602418 7	PU 10	Item-No. 0200x00082303 (3 m cord)	EAN 401209602419 4	PU 10	Item-No. 0200x00082305 (5 m cord)	EAN 401209602448 4	PU 7	590 x 74 x 47 mm Dimensions (L x W x H) 582 mm Fixing Dimension
Item-No. 0200x00082301 (1,5 m cord)	EAN 401209602418 7	PU 10									
Item-No. 0200x00082303 (3 m cord)	EAN 401209602419 4	PU 10									
Item-No. 0200x00082305 (5 m cord)	EAN 401209602448 4	PU 7									